



251 Mason Way
City Of Industry, Ca 91744

Phone: (877) 775-2586

Fax: (877) 274-8800

Tiffany Sliding Door

Installation Instructions

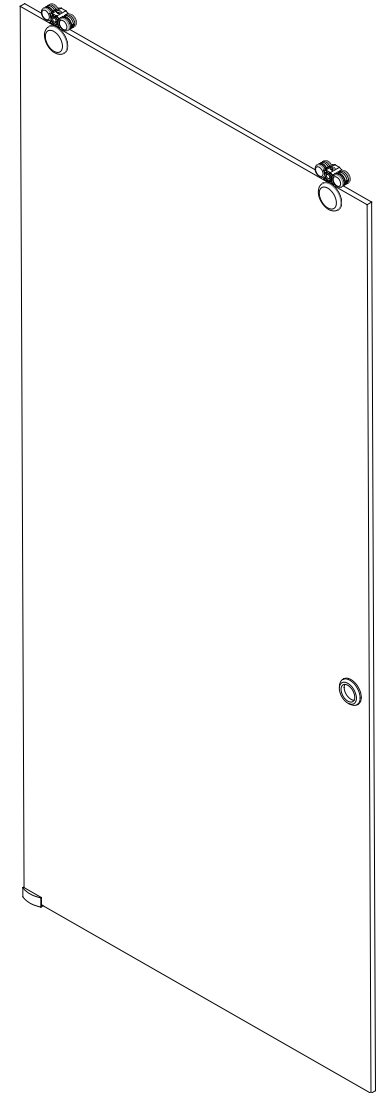
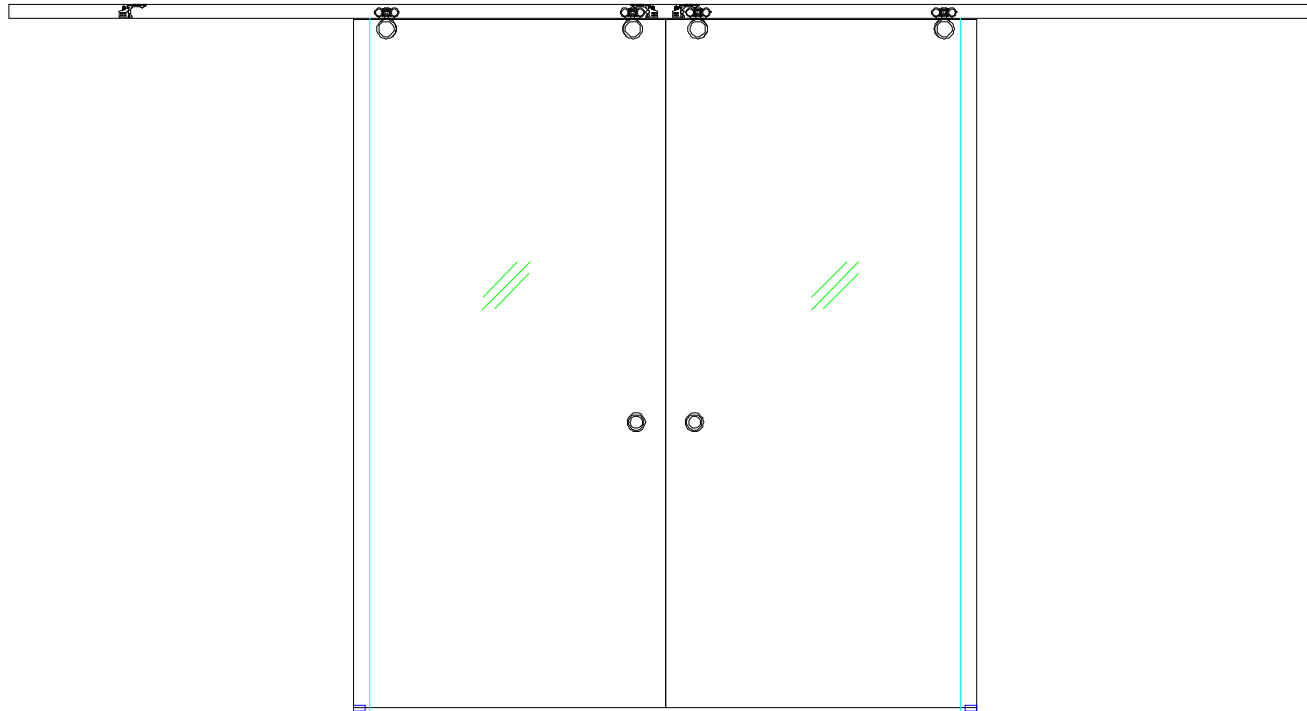



251 Mason Way
City Of Industry, Ca 91744

Phone: (877) 775-2586

Fax: (877) 274-8800

Tiffany Sliding Door Roller

Parts list

ITEM NO.	PART NUMBER	QTY.
1	TIFFANY HOLDER CAP	1
2	TIFFANY-D	2
3	TIFFANY GASKET	2
4	THREADED ROD	1
5	FASTENER SCREW FOR ROD	1
6	TIFFANY-C	1
7	FASTENER SCREW	2
8	TIFFANY CAP	1
9	TIFFANY TOP ROLLER	1
10	TIFFANY WHEEL	4

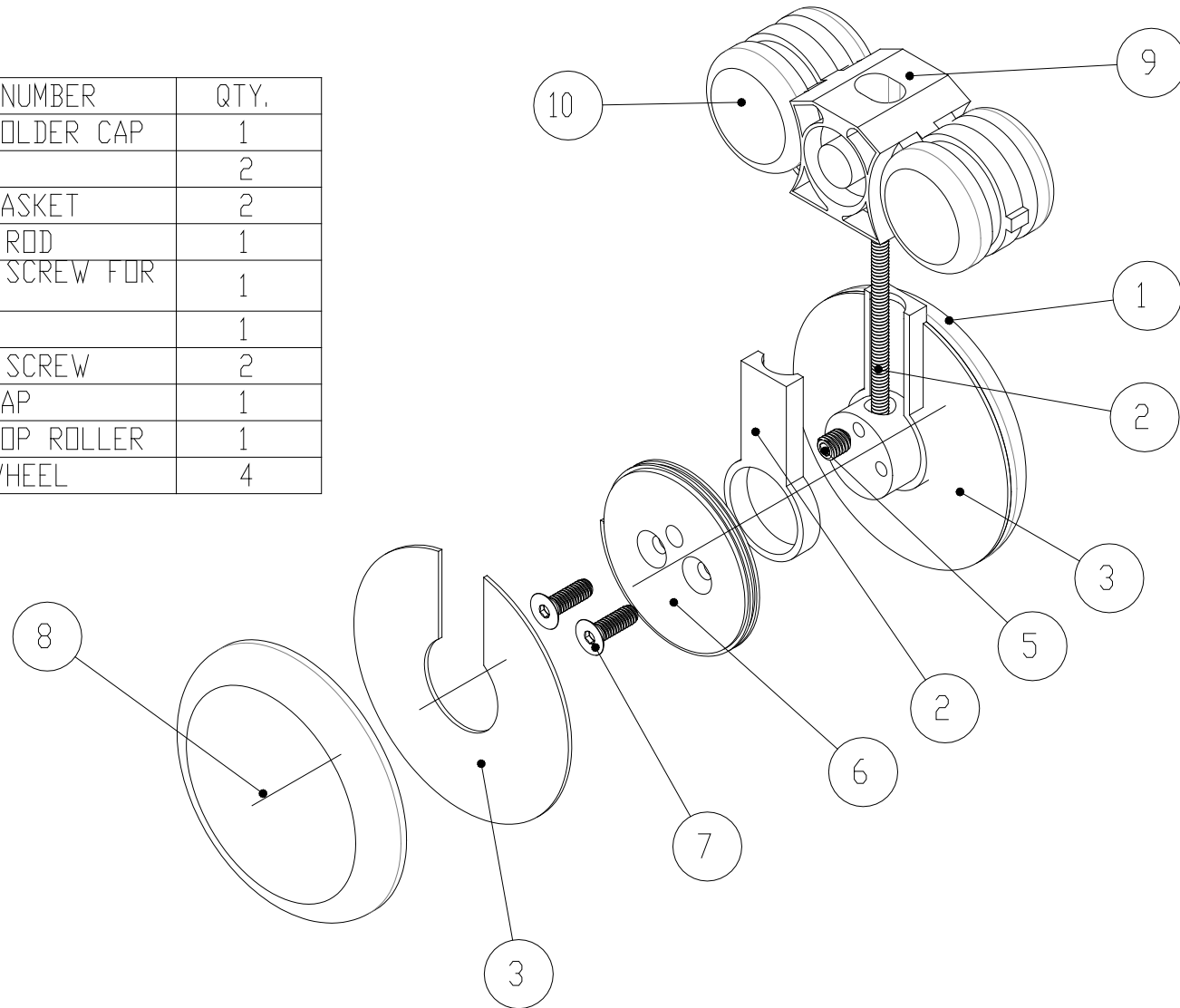

Tiffany Installation Instructions

(1)

Place Tiffany Gasket on the glass

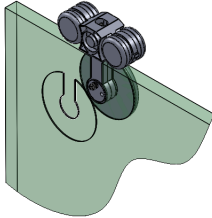

(2)

Place Tiffany "C" on the glass

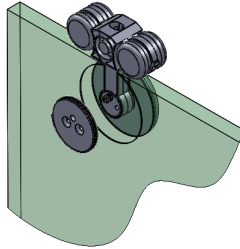

(3)

Fasten Tiffany "C" with the Screws

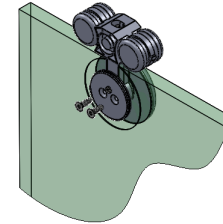

(4)

Fasten Tiffany Cap

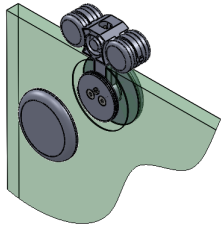

Tiffany on glass installation, completed

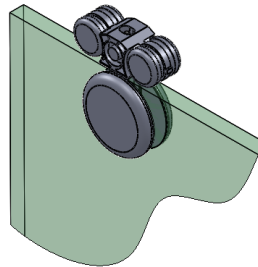

(5)

Slide Tiffany Stop into, track

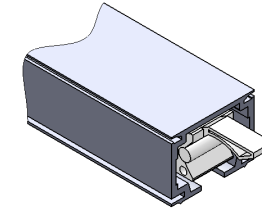

(6)

Install Guide

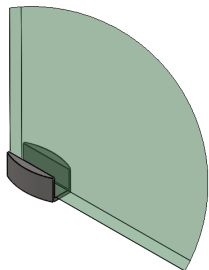

(7)

Slide Tiffany sliding roller into, Tiffany Track

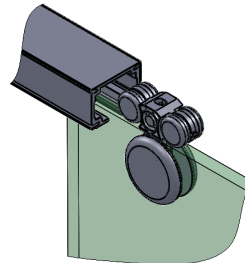

(8)

Install cladding & endcap

